

Part number

MHV 32.32



Hood, C-TYPE series, with 4 pegs, M32 top cable entry, size "77.62"

Product description

Product type	Hood
Series	C-TYPE
Closing type	With 4 pegs
Size	Size "77.62"
Cable entry	Top cable entry with adapter M32

Technical data

IP degree of protection	IP65 / IP66 / IP69
--------------------------------	--------------------

Further technical details

Weight	422,00 g
Operating temperature range (min, max)	-40°C...+125°C

Material properties

Colour	RAL 7040 grey
RoHs conformity	Compliant
China RoHs - EFUP	E
REACH SVHC substances	No
SCIP number	15deaf78-e939-4401-a0b0-e2228ca32a03

Approvals / Standards

Certifications	DNV, BV
UL	ECBT2
cUL	ECBT8

General ordering information

EAN13 code	8015747056311
eCl@ss 8.1	27440202
ETIM 7.0	EC000437

Packaging Information

Packaging length	370,00 mm
Packaging height	140,00 mm
Packaging width	210,00 mm
Packaging weight	3,64 kg
Packaging volume	10,88 dm ³
Packaging description	Carton box
Packaging quantity	8 Pcs
Packaging EAN code	8015747056328
Sub-packaging weight	0,46 kg
Sub-packaging description	Plastic packaging
Sub-packaging quantity	1 Pcs
Sub-packaging EAN barcode	8015747056335

Part number

MHV 32.32



Catalogue drawings

**CHO - CHV MHO/MFO/MFV - MHV
MMV (MMAV)**

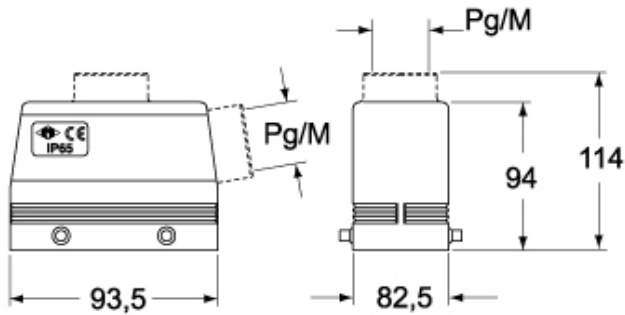

CHV G - MHV G - MFV G

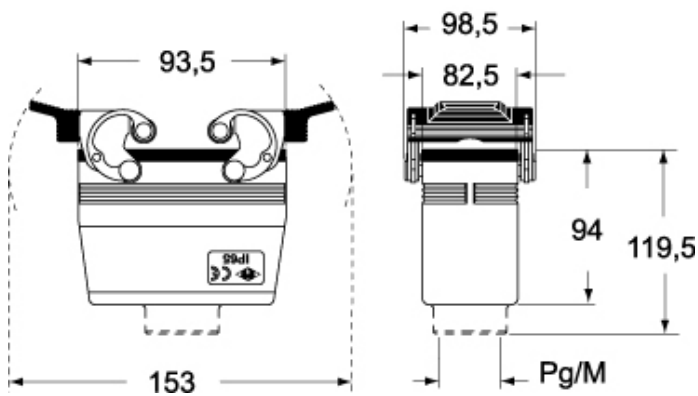

Notes

Dimensions shown in mm are not binding and may be changed without notice.