

Part number

**MHP 32 LS40**



Surface mounting housing, C-TYPE series, with 1 lever, M40 cable entry, size "77.62", with metal cover

Product description	
<b>Product type</b>	Surface mounting housing
<b>Series</b>	C-TYPE
<b>Closing type</b>	With 1 lever
<b>Size</b>	Size "77.62"
<b>Cable entry</b>	M40
<b>Specification</b>	With metal cover
Technical data	
<b>IP degree of protection</b>	IP65 / IP66 / IP69
Further technical details	
<b>Weight</b>	795,00 g
<b>Operating temperature range (min, max)</b>	-40°C...+125°C

Material properties	
<b>Colour</b>	RAL 7040 grey
<b>RoHs conformity</b>	Compliant
<b>China RoHs - EFUP</b>	E
<b>REACH SVHC substances</b>	No
Approvals / Standards	
<b>Certifications</b>	DNV, BV
<b>UL</b>	ECBT2
<b>cUL</b>	ECBT8
General ordering information	
<b>EAN13 code</b>	8015747055017
<b>eCl@ss 8.1</b>	27440202
<b>ETIM 7.0</b>	EC000437
Packaging Information	
<b>Packaging length</b>	290,00 mm
<b>Packaging height</b>	140,00 mm
<b>Packaging width</b>	215,00 mm
<b>Packaging weight</b>	3,67 kg
<b>Packaging volume</b>	8,73 dm <sup>3</sup>
<b>Packaging description</b>	Carton box
<b>Packaging quantity</b>	4 Pcs
<b>Packaging EAN code</b>	8015747211161
<b>Sub-packaging weight</b>	0,92 kg
<b>Sub-packaging description</b>	Plastic packaging
<b>Sub-packaging quantity</b>	1 Pcs
<b>Sub-packaging EAN barcode</b>	8015747055024

Part number

# MHP 32 LS40



Catalogue drawings

## CHP L CAP L - MHP L MAP L

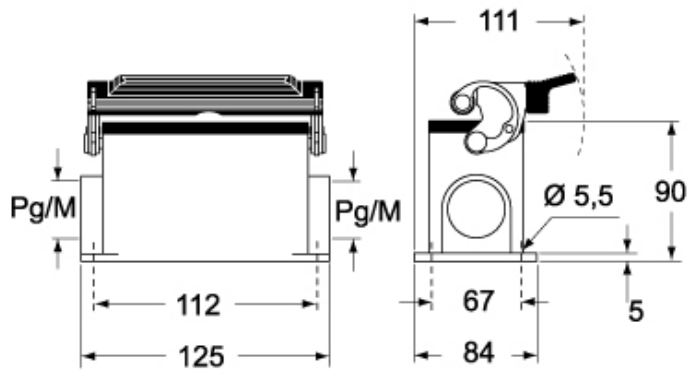

## CHP LS CAP LS - MHP LS MAP LS

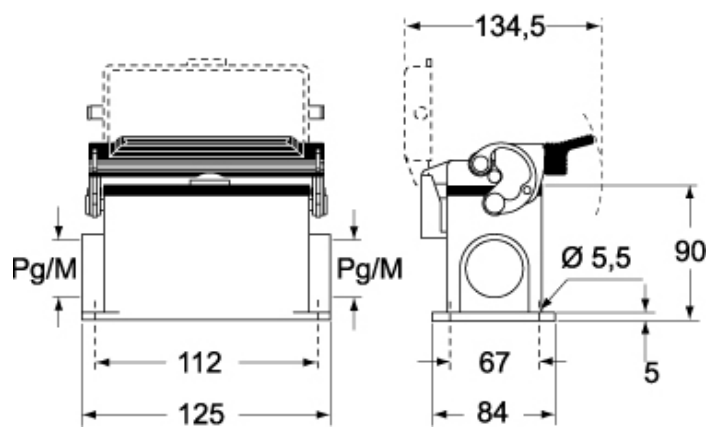

## Notes

Dimensions shown in mm are not binding and may be changed without notice.